

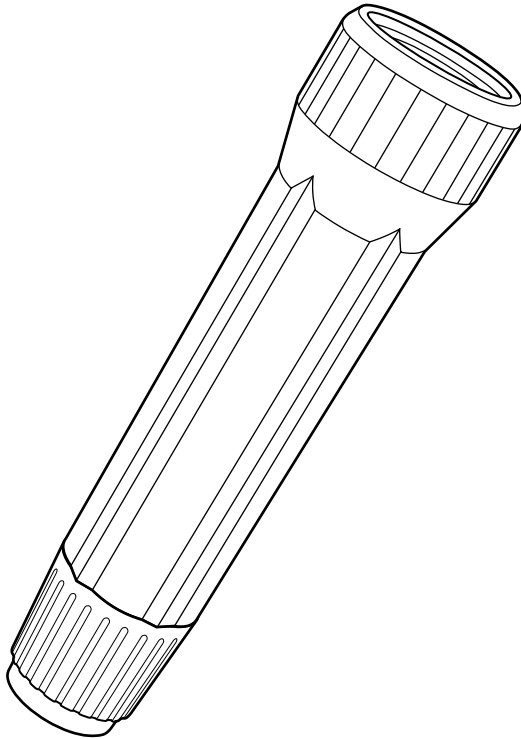

GRIP HANDLE

REPLACEMENT INSTRUCTIONS



web: www.sprayers-plus.com

email: info@sprayers-plus.com

Parts in the package

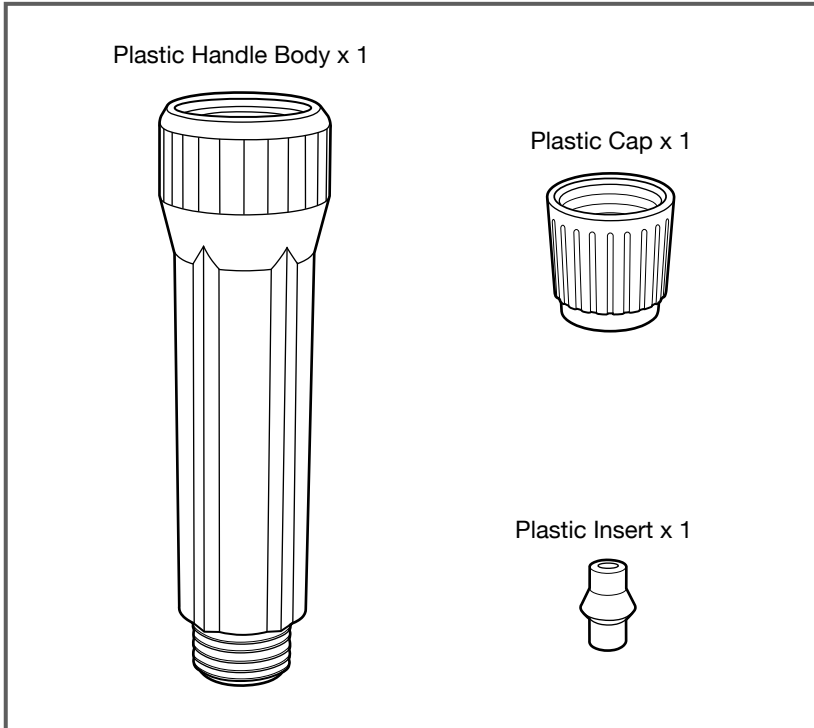

GENERAL INSTRUCTIONS - READ THESE FIRST

This plastic handle assembly replaces the following plastic handles of SprayersPlus products:

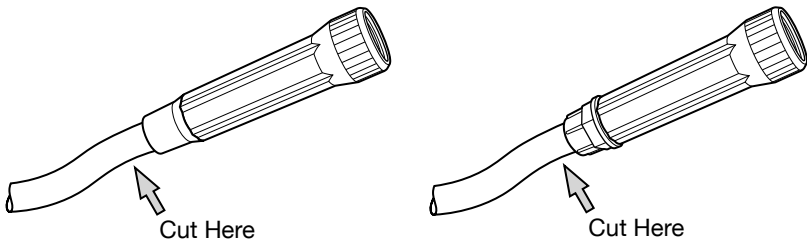

Cut the hose to start installing the new plastic handle assemble.

Note: you also need to cut the hose to start when you are replace a plastic handle assemble of the identical type as the one in this package.

Installing the Plastic Handle Assemble

Step-1: Slide the plastic cap along the hose and keep it at least 12 inches from the cut.

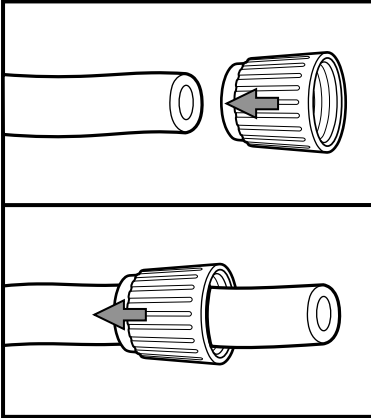

Step-2: Immerse the hose into hot water (70 to 80°C) for about 10 seconds (to soften the hose).

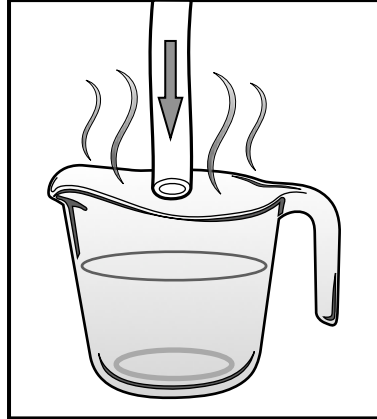

Step-3: Push the plastic insert into the hose; press it on the table until it is flush.

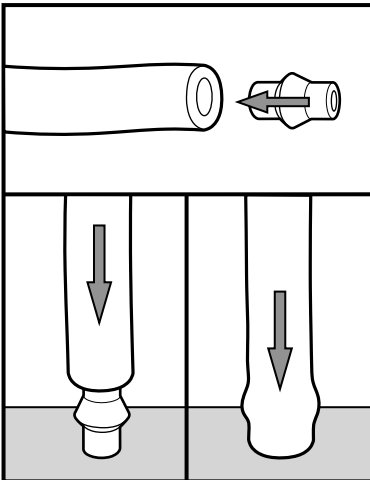

Step-4: Slide the plastic cap up to screw it to the plastic handle body, and YOU ARE ALL SET !

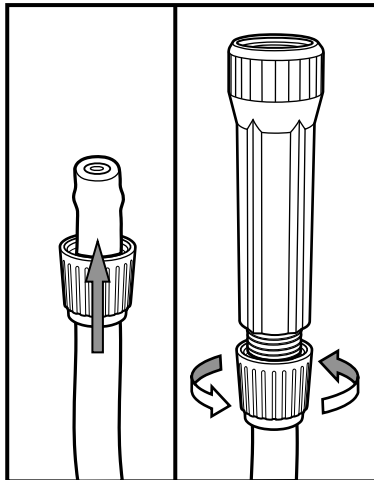

Note: Be cautious when handling hot water. Use appropriate protection (such as wearing leather gloves) when handling the hose while it is hot.

WARRANTY INFORMATION

Statement of Limited Warranty

Sprayers Plus shall warrant the equipment and replacement parts described in this manual and shall repair or replace parts and components which, under normal operation and wear, in accordance with technical recommendations, show DEFECTS IN MATERIAL OR WORKMANSHIP, based on the following conditions.

Warranty period

Every sprayer is covered by a one-year warranty against defects in workmanship and materials, with a 6-month limited warranty on consumable parts from the date of sale to the original purchaser.

Warranty Registration

Please visit: www.sprayers-plus.com/warranty

Sprayers Plus shall honor this warranty, free of charge, if any part or component shows defect in MATERIAL OR WORKMANSHIP, after final analysis at the factory.

Please keep your receipt and complete the warranty registration within 14 days of purchase to ensure your sprayer is fully protected.

This Warranty shall be null and void in case of:

- Misuse of the equipment against specifications in this manual, overwork or accidents.
- Preventive / remedial maintenance performed by unauthorized people or parties.
- Use of parts and components not supplied by Sprayers Plus.
- Modification of the equipment or any characteristic of the original design.

This Warranty shall exclude

- Parts which show wear and tear due to normal usage,
UNLESS THEY SHOW DEFECTS IN WORKMANSHIP, ASSEMBLY OR MATERIAL.
- Damages resulting from accidents.
- Transportation or freight of the equipment, parts, and components in case such warranty is not approved.
- Transportation and travel time of technician.



web: www.sprayers-plus.com
email: info@sprayers-plus.com